

CCSP-6228-0403

Compensated Choke
Kompensierte Drossel

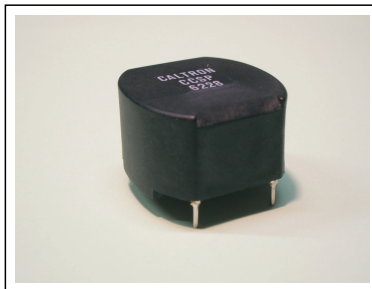

COMPLIANT
ENTSPRECHEN

APPROVED
GENEHMIGT



MECHANICAL DIMENSIONS / MECHANISCHE DIMENSIONEN

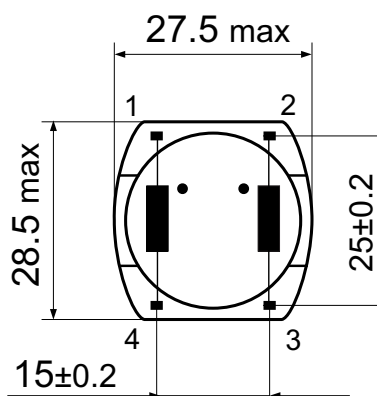
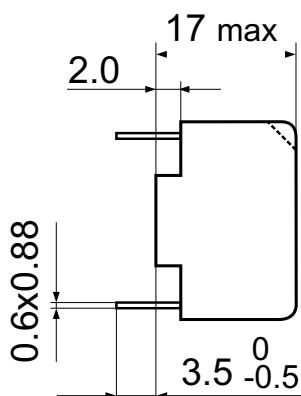
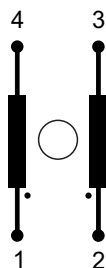

DIAGRAM / SCHEMA



FEATURES / EIGENSCHAFTEN

Climatic Class Klimaklasse	25/100/21 as per IEC 60068-1
Inflammability Brennbarkeit	UL 94 V-0
Current Derating Stromrücknahme	over 40°C: $I = I_N * \sqrt{(100 - \theta a) / 60}$
L_N Measured L_N Gemessen	according to EN 60938-2
R_{Cu} Measured R_{Cu} Gemessen	at 25 °C ambient temperature

ELECTRICAL DATA / ELEKTRISCHE WERTE

Operating Voltage / Betriebsspannung	$U_R = 250$ (max)	VAC
Current / Strom	$I_N = 4$	A
Inductance / Induktivität	$L_N = 2 \times 2.7 - 30\% + 50\%$	mH
Cu-Resistance / Cu-Widerstand	$R_{Cu} = 2 \times 48 \pm 10\%$	mΩ
Power dissipation / Verlustleistung	$P_{Loss} = 1500$	mW
Test voltage / Prüf-Spannung	$U = 1800 / 2$ sec.	VAC
Res. Frequency / Res. Frequenz	$f_{res.} = 0.5$ (approx)	MHz

Compensated Choke
Kompensierte Drossel

TECHNICAL DATA SHEET
TECHNISCHES DATENBLATT

Part no.
CCSP-6228-0403

Tot. fogli/sheet : 1
Foglio/sheet nr. : 1