

CLTP-6123-02D3

Non Compensated Choke
Nicht Kompensierte Drossel

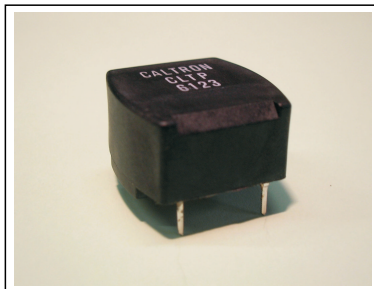

COMPLIANT
ENTSPRECHEN



MECHANICAL DIMENSIONS / MECHANISCHE DIMENSIONEN

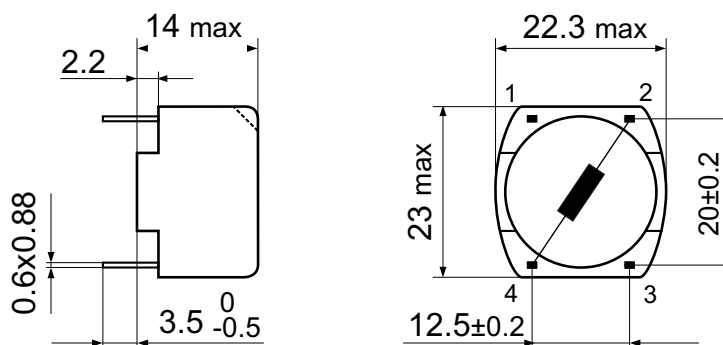

DIAGRAM / SCHEMA



FEATURES / EIGENSCHAFTEN

Climatic Class Klimaklasse	40/125/21 as per IEC 60068-1
Inflammability Brennbarkeit	UL 94 V-0
Current Derating Stromrücknahme	over 70°C: $I = I_N * \sqrt{(125 - \theta_a) / 55}$
L _o Measured L _o Gemessen	according to EN 60938-2
R _{cu} Measured R _{cu} Gemessen	at 25 °C ambient temperature

ELECTRICAL DATA / ELEKTRISCHE WERTE

Operating Voltage / Betriebsspannung	U_R = 600 (max)	VDC
Current / Strom	I_N = 2	A
Inductance / Induktivität	L_o = 270 ± 15%	µH
Cu-Resistance / Cu-Widerstand	R_{Cu} = 170 ± 10%	mΩ
Power dissipation / Verlustleistung	P_{Loss} = 700	mW
Test voltage / Prüf-Spannung	U = 2000 / 2 sec.	VAC
Res. Frequency / Res. Frequenz	f_{res.} = 2 (approx)	MHz

Non Compensated Choke Nicht Kompensierte Drossel	TECHNICAL DATA SHEET TECHNISCHES DATENBLATT	Part no. CLTP-6123-02D3	Tot. fogli/sheet : 1 Foglio/sheet nr. : 1
---	--	-----------------------------------	--