

CLTT-6131-02D5

Non Compensated Choke
Nicht Kompensierte Drossel

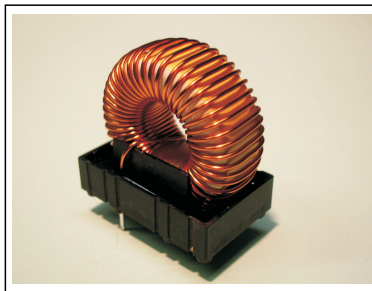

COMPLIANT
ENTSPRECHEN



MECHANICAL DIMENSIONS / MECHANISCHE DIMENSIONEN

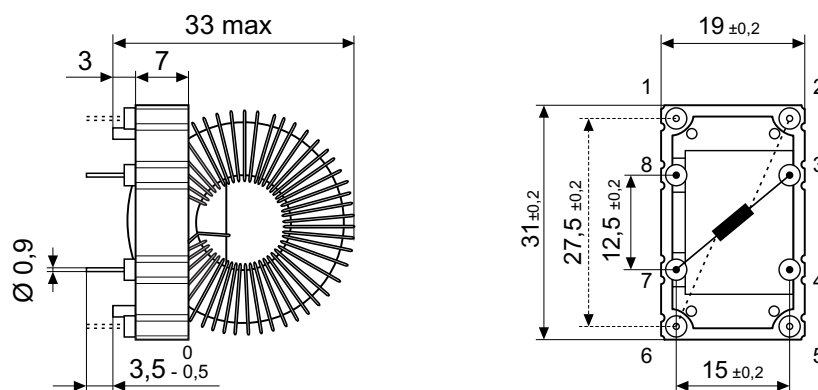

DIAGRAM / SCHEMA



FEATURES / EIGENSCHAFTEN

Climatic Class Klimaklasse	40/125/21 as per IEC 60068-1
Inflammability Brennbarkeit	UL 94 V-0
Current Derating Stromrücknahme	over 70°C: $I = I_N * \sqrt{(125 - \theta) / 55}$
L _o Measured L _o Gemessen	according to EN 60938-2
R _{cu} Measured R _{cu} Gemessen	at 25 °C ambient temperature

ELECTRICAL DATA / ELEKTRISCHE WERTE

Operating Voltage / Betriebsspannung	U_R = 600 (max)	VDC
Current / Strom	I_N = 2	A
Inductance / Induktivität	L_o = 560 ± 15%	µH
Cu-Resistance / Cu-Widerstand	R_{Cu} = 265 ± 10%	mΩ
Power dissipation / Verlustleistung	P_{Loss} = 1000	mW
Test voltage / Prüf-Spannung	U = 2000 / 2 sec.	VAC
Res. Frequency / Res. Frequenz	f_{res.} = 2.5 (approx)	MHz

Non Compensated Choke
Nicht Kompensierte Drossel

TECHNICAL DATA SHEET
TECHNISCHES DATENBLATT

Part no.
CLTT-6131-02D5

Tot. fogli/sheet : 1
Foglio/sheet nr. : 1